

Box above each sign indicates Size
 Characters directly below sign indicate Part Number
 Gray box below Part Number indicates Max Number of Characters per line / Total # of Lines Possible
 Maximum Numerical Characters per sign is 5
 More ordering information on page 6

Insert Card Template: Microsoft Word® insert card templates are available for download at www.parissigns.com

type A - Restroom with Text, Symbol and Braille - ADA

8"x8"



A.88.1



A.88.2



A.88.3



A.88.4



A.88.5



A.88.6

Part Number

9"x9"



A.99.1



A.99.2



A.99.3



A.99.4



A.99.5



A.99.6

type B - Room# with Text, Insert and Braille - ADA

5"x7"



B.57.1

9/1



B.57.2

0



B.57.3

0



B.77.1

9/2



B.77.2

9/2



B.77.3

9/2



B.77.4

9/1



B.77.5

9/1

6"x8"



B.68.1

11/2



B.68.2

11/1



B.68.3

11/1



B.88.1

11/3



B.88.2

11/2



B.88.3

11/2



B.88.4

11/2



B.88.5

11/2

7"x9"



B.79.1

13/2



B.79.2

13/2



B.79.3

13/2



B.99.1

13/4



B.99.2

13/3



B.99.3

13/3



B.99.4









13/2



















B.99.5

13/2







type C - Text, Insert and Braille - ADA

5"x7"			7"x7"				
							
C.57.1	C.57.2	C.57.3	C.77.1	C.77.2	C.77.3	C.77.4	C.77.5
9/2	9/1	9/1	9/3	9/3	9/3	9/2	9/2







6"x8"			8"x8"				
							
C.68.1	C.68.2	C.68.3	C.88.1	C.88.2	C.88.3	C.88.4	C.88.5
11/3	11/2	11/2	11/4	11/3	11/3	11/3	11/3

7"x9"			9"x9"				
							
C.79.1	C.79.2	C.79.3	C.99.1	C.99.2	C.99.3	C.99.4	C.99.5
13/3	13/3	13/3	13/5	13/4	13/4	13/3	13/3

type D - Room# with Text and Braille - ADA

4"x7"	5"x7"	7"x7"	6"x8"	8"x8"	7"x9"	9"x9"
						
D.47.1	D.57.1	D.77.1	D.68.1	D.88.1	D.79.1	D.99.1
9/1	9/2	9/3	11/2	11/4	13/3	13/5

type E - Text and Braille - ADA

4"x7"	5"x7"	7"x7"	6"x8"	8"x8"	7"x9"	9"x9"
						
E.47.1	E.57.1	E.77.1	E.68.1	E.88.1	E.79.1	E.99.1
9/2	9/3	9/4	11/3	11/4	13/4	13/5

type F - Room# with Text, Full Insert Card and Braille - ADA

4"x7"	5"x7"	7"x7"	6"x8"	8"x8"	7"x9"	9"x9"
F.47.1	F.57.1	F.77.1	F.68.1	F.88.1	F.79.1	F.99.1
9/1	9/2	9/3	11/2	11/4	13/3	13/5

type G - Text, Full insert Card and Braille - ADA

4"x7"	5"x7"	7"x7"	6"x8"	8"x8"	7"x9"	9"x9"
G.47.1	G.57.1	G.77.1	G.68.1	G.88.1	G.79.1	G.99.1
9/2	9/3	9/4	11/3	11/4	13/4	13/5

type H - Room#, Text, Enter/Exit Slider and Braille - ADA

1.4"x7"	5"x7"	7"x7"	1.4"x8"	6"x8"	8"x8"
H.17.1	H.57.1	H.77.1	H.18.1	H.68.1	H.88.1
0/0	9/1	9/2	0/0	11/1	11/3

1.4"x9"	7"x9"	9"x9"
H.19.1	H.79.1	H.99.1
0/0	13/2	13/3

Part Number
 Max character # per line/# of lines
 Max 5 numbers or Digits

type J - Room#, with Text and Slider - ADA

5"x7"	7"x7"	5"x8"	8"x8"	7"x9"	9"x9"
J.57.1	J.77.1	J.58.1	J.88.1	J.79.1	J.99.1
9/2	9/3	11/2	11/4	13/3	13/4

type K - Room# and without room #, Text and Symbol - ADA - other symbols are available on order form

7"x7"	8"x8"	9"x9"	7"x7"	8"x8"	9"x9"
K.77.1	K.88.1	K.99.1	K.77.2	K.88.2	K.99.2
9/2	11/2	13/2	10/2	11/2	13/2

type M - Tag Sign with Number, Letter or Symbol - ADA

3"x3"	5"x5"	7"x7"	8"x8"	9"x9"
M.33.1	M.55.1	M.77.1	M.88.1	M.99.1
1/1	2/1	2/1	2/1	2/1

type N - Rider with insert card - can be place below any sign to add a changable panel - Non-ADA

1.4"x7"	2.4"x7"	3.4"x8"	1.4"x8"	2.4"x8"	3.4"x8"
N.17.1	N.27.3	N.37.5	N.18.1	N.28.3	N.38.5
1.4"x9"	2.4"x9"	3.4"x8"			
N.19.1	N.29.3	N.38.5			

type P - Text with Braille (may also contain directional arrows) - ADA

3"x9" 3"x12" 6"x12" 9"x12" 12"x12"

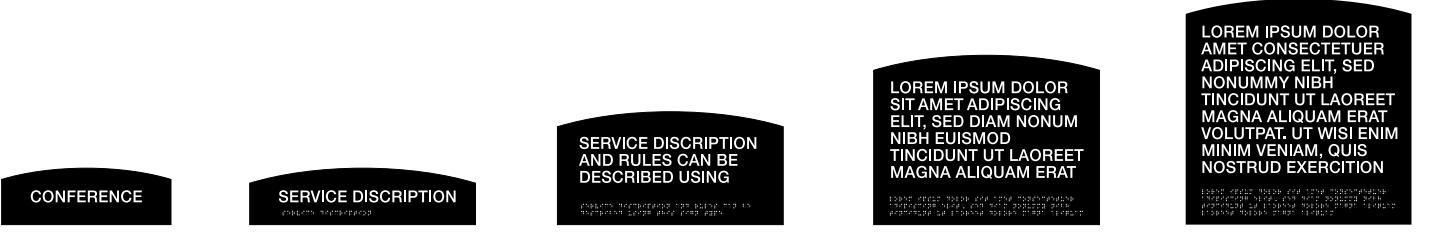

11/1 19/1 19/3 19/6 19/9
8/1 13/1 13/2 13/3 13/5

6"x18" 9"x18" 12"x18"



P.618.1	P.918.1	P.1218.1	Part Number	text height
26/3	26/5	26/7	Max character # per line/# of lines	5/8"
17/2	17/3	17/5	Max character # per line/# of lines	1"

type Q - Text is Reverse painted, No Braille (may also contain directional arrows) - Non-ADA

3"x9" 3"x12" 6"x12" 9"x12" 12"x12"



11/1 19/1 19/5 19/8 19/12
8/1 13/1 13/3 13/4 13/7

6"x18" 9"x18" 12"x18"



Q.618.1	Q.918.1	Q.1218.1	Part Number	text height
26/5	26/8	26/12	Max character # per line/# of lines	5/8"
17/3	17/5	17/7	Max character # per line/# of lines	1"

type T - Frame for paper insert 6.5x6.5, 8.5x8.5, 8.5x11, 8.8x14 and 11x17 - Non-ADA

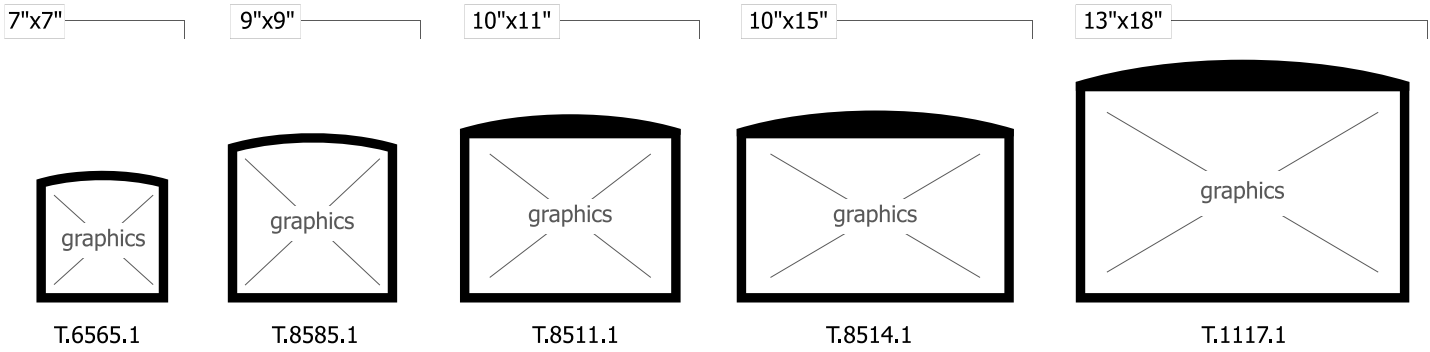

type V - Directional Signage - 2 sizes - Non-ADA wall or ceiling mounted

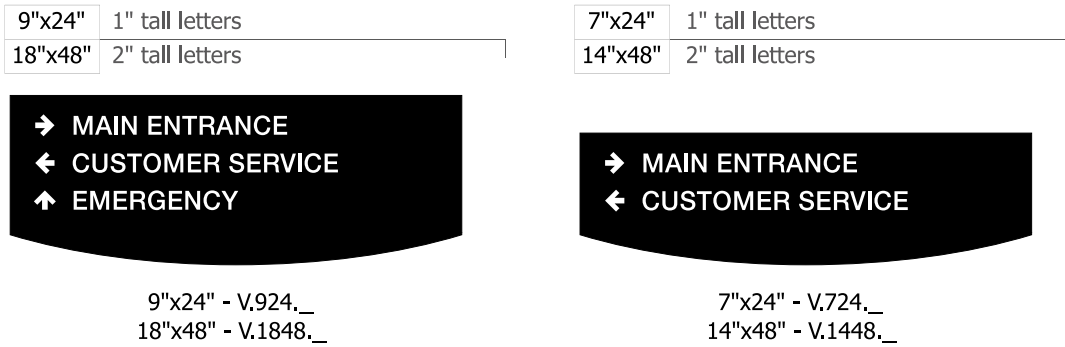

Single Sided add ".1", Double Sided add ".2" after "V.924", if Double sided 1/2" flange at the top with brushed aluminum bracket.
If sign is double sided multiply Price x 2.

type W - Directory - Non-ADA

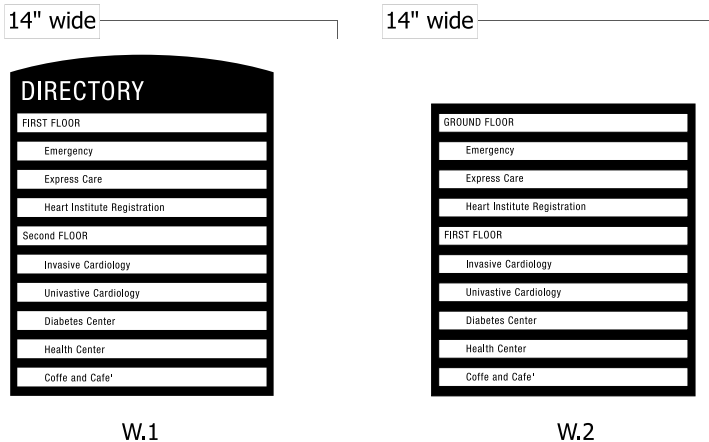

type X - Stairwell Egress Text, Arrows and Braille - ADA



Available with 10, 15 (additional cost) and 20 (additional cost) windows
to order follow part number under Directory with .10, .15 or .20 for quantity of windows

Customization/Additional Cost

Wall Mount add ".WM", Ceiling Mounted add ".CM" after "Original Sign Part #", 1/2" flange at the top or side with brushed aluminum bracket.
Decorative Graphic borders or additional colors can be added

Colors other than Standard are available with an additional charge. This applies with every order.

If Radius Corners are required, ".RC" should follow the Part #; example A.99.1.RC

Custom styles are available for an initial design fee on first order, no further cost apply to future orders.

Custom width signs can be made to match, these can be used in areas that standard sign will not fit.

Custom Size signs of any style are available, call for custom pricing.

A stand can be added to the back of any of the signs to make "Table Top."

All single sided wall mounted signs come standard with VHB 2 sided mounting tape applied to back